



LXi — The Next Generation in Heating Technology

Integrating the most advanced features in every aspect — from superior hydraulic design, lightest and strongest composite material construction — to a technologically innovative control system, the LXi brings the future of heating comfort to your pool.

The feature rich control panel has a user-friendly backlit display. Built-in one-touch automation makes pool-to-spa switching simple.



LXi Control Panel

Freeze protection and Jandy's exclusive

Maintain Temp Function* are just a few of the many features that bring complete control and comfort to your pool and spa today.

*Requires field supplied pump relay (p/n R0467200) and additional field wiring.

**Optional kit

COMPACT

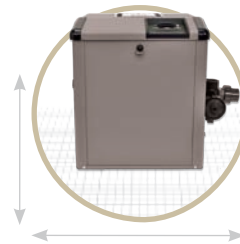

Jandy's new LXi is the easiest heater to install. The LXi is 33% lighter, with a 15% smaller footprint. Convenient **"Hot Wheels" for delivery to equipment pad.

POWERFUL



The LXi header improves entire circulation system efficiency. Offset plumbing and 2" universal unions provide added flexibility for simplified, direct connections.

RELIABLE

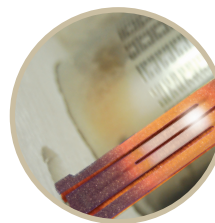

Low NOx, fan-assisted combustion and Hot Surface Ignition System provides maximum performance.

Multiple venting options including sidewall, top or rear connections.

EFFICIENT

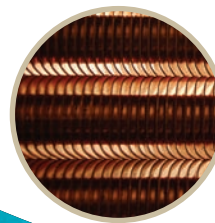

High efficiency C-Fin heat exchanger is designed for lower operating cost and greater savings.

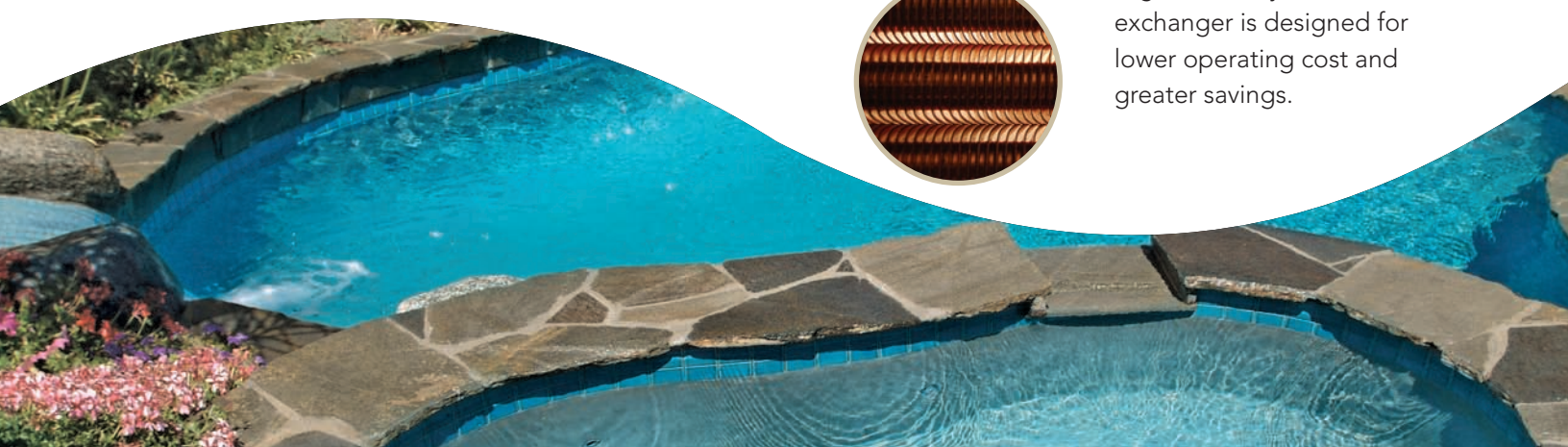

More Comfort with Jandy Technology

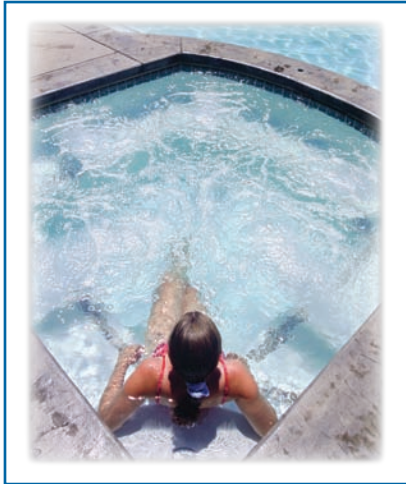

LXi HEATERS

The LXi advanced digital control system is your key to comfort. Built-in automation makes pool/spa switching simple. Additional control panels can be added for ultimate convenience in the home, pool house or at the equipment pad.

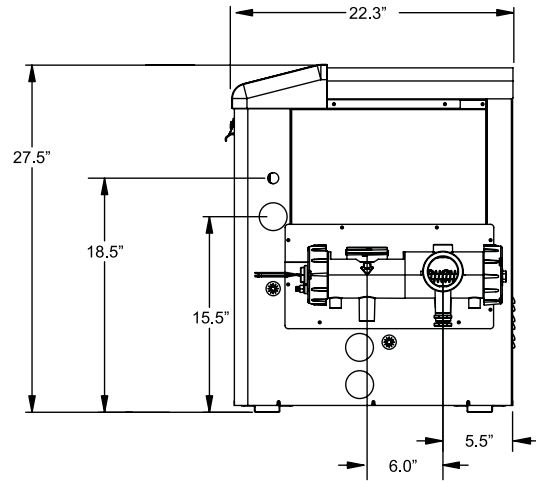

LXi PERFORMANCE CHARTS

The Pool Sizing Guide below shows the maximum pool surface area LXi models 250, 300 & 400 will heat based on the Temperature Difference* between the air temperature during the coldest month the pool is used and the desired pool temperature. Figures are based on average wind conditions and average pool depth.

POOL SIZING GUIDE

Model	250		300		400	
Temp Diff*	Maximum Area Heated (width x length)					
	0 Wind	3 ½ MPH	0 Wind	3 ½ MPH	0 Wind	3 ½ MPH
15°F	1750	1300	2300	1725	2800	2100
20°F	1300	1000	1725	1300	2100	1600
25°F	1050	800	1400	1050	1700	1280
30°F	850	650	1550	875	1400	1050
35°F	750	570	1000	750	1200	900

The Spa Sizing Guide below details the time required for each model to raise spa temperature by 30°F.

SPA SIZING GUIDE

Model	250		300		400	
Spa Size	Time Required to Raise Temp 30°					
200 Gallons	15 Minutes	13 Minutes	10 Minutes			
400 Gallons	30 Minutes	25 Minutes	20 Minutes			
600 Gallons	45 Minutes	35 Minutes	30 Minutes			
800 Gallons	60 Minutes	50 Minutes	40 Minutes			
1000 Gallons	75 Minutes	60 Minutes	50 Minutes			

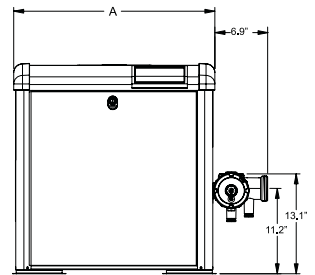

Specifications for LXi Heaters:

Model No.	"A" Width	Height	Depth	Vent (Dia.)	Shipping Weight	Heater Weight
250	23.5"	27.5"	22.3"	5"	175 LBS	135 LBS
300	26.5"	27.5"	22.3"	6"	182 LBS	142 LBS
400	32.0"	27.5"	22.3"	7"	201 LBS	161 LBS

See your Jandy Sales Representative for more information

ALL JANDY PRODUCTS WORK SEAMLESSLY TOGETHER

Jandy Control Systems manage our complete line of technologically advanced products.



Pumps • Filters • Heaters • Heat Pumps
Controls • Lights • Water Purification Systems • Valves
Water Features • Cleaners • Accessories

